

■ Features :

- Universal AC input / Full range
- Protections: Short circuit / Over current / Over voltage
- Built-in active PFC function
- Cooling by free air convection
- Class 2 power unit
- Output current level adjustable
- 100% full load burn-in test
- High reliability
- Suitable for built-in applications of LED lighting
- 2 years warranty



**SPECIFICATION**

MODEL		PLP-30-12	PLP-30-24	PLP-30-48
OUTPUT	DC VOLTAGE	12V	24V	48V
	CONSTANT CURRENT OPERATION VOLTAGE Note.5	9 ~ 12V	18 ~ 24V	36 ~ 48V
	RATED CURRENT	2.5A	1.3A	0.63A
	CURRENT RANGE	0 ~ 2.5A	0 ~ 1.3A	0 ~ 0.63A
	RATED POWER	30W	31.2W	30.24W
	RIPPLE & NOISE (max.) Note.2	2Vp-p	2.4Vp-p	4.8Vp-p
	CURRENT ADJ. RANGE	1.875 ~ 2.5A	0.975 ~ 1.3A	0.475 ~ 0.63A
	VOLTAGE TOLERANCE Note.3	±10%		
	LINE REGULATION	±3.0%		
LOAD REGULATION	±5.0%			
SETUP TIME	1200ms / 230VAC 2200ms / 115VAC at full load			
INPUT	VOLTAGE RANGE Note.4	90 ~ 264VAC 127 ~ 370VDC		
	FREQUENCY RANGE	47 ~ 63Hz		
	POWER FACTOR (Typ.)	PF>0.9 at 75 ~ 100% load , 115VAC / 230VAC		
	EFFICIENCY (Typ.)	83%	85.5%	86.5%
	AC CURRENT (Typ.)	0.4A/115VAC 0.2A/230VAC		
	INRUSH CURRENT (max.)	COLD START 25A(twidth=45μs measured at 50% Ipeak) at 230VAC		
LEAKAGE CURRENT	<0.75mA / 240VAC			
PROTECTION	OVER CURRENT Note.5	100 ~ 110% Protection type : Constant current limiting, recovers automatically after fault condition is removed		
	SHORT CIRCUIT	Hiccup mode, recovers automatically after fault condition is removed.		
	OVER VOLTAGE	15 ~ 18V	28 ~ 33V	57 ~ 63V
ENVIRONMENT	WORKING TEMP.	-30 ~ +70°C (Refer to "Derating Curve")		
	WORKING HUMIDITY	20 ~ 95% RH non-condensing		
	STORAGE TEMP., HUMIDITY	-40 ~ +80°C , 10 ~ 95% RH		
	TEMP. COEFFICIENT	±0.03%/°C (0 ~ 50°C)		
	VIBRATION	10 ~ 500Hz, 2G 12min./1cycle, period for 72min. each along X, Y, Z axes		
SAFETY & EMC	SAFETY STANDARDS	UL8750, TUV EN61347-1, EN61347-2-13, CSA C22.2 No. 250.0-08(except for 48V) approved ; design refer to UL60950-1		
	WITHSTAND VOLTAGE	I/P-O/P:3.75KVAC I/P-FG:2KVAC O/P-FG:0.5KVAC		
	ISOLATION RESISTANCE	I/P-O/P, I/P-FG, O/P-FG:100M Ohms / 500VDC / 25°C / 70% RH		
	EMC EMISSION	Compliance to EN55015, EN61000-3-2 Class C(≥ 75% load); EN61000-3-3		
OTHERS	EMC IMMUNITY	Compliance to EN61000-4-2,3,4,5,6,8,11, EN55024,EN61547, light industry level, criteria A		
	MTBF	580.8K hrs min. MIL-HDBK-217F (25°C)		
	DIMENSION	101.6*50.8*26.6mm (L*W*H)		
NOTE	PACKING	0.12Kg; 108pcs/13Kg/0.89CUFT		
	NOTE	<ol style="list-style-type: none"> <li>1. All parameters NOT specially mentioned are measured at 230VAC input, rated load and 25°C of ambient temperature.</li> <li>2. Ripple &amp; noise are measured at 20MHz of bandwidth by using a 12" twisted pair-wire terminated with a 0.1uf &amp; 47uf parallel capacitor.</li> <li>3. Tolerance : includes set up tolerance, line regulation and load regulation.</li> <li>4. Derating may be needed under low input voltage. Please check the static characteristics for more details.</li> <li>5. Constant current operation region is within 75% ~100% rated output voltage. This is the suitable operation region for LED related applications, but please reconfirm special electrical requirements for some specific system design.</li> <li>6. The power supply is considered as a component that will be operated in combination with final equipment. Since EMC performance will be affected by the complete installation, the final equipment manufacturers must re-quality EMC Directive on the complete installation again.</li> <li>7. Heat Sink HS1,HS2 can not be shorted.</li> <li>8. Direct connecting to LEDs is suggested, but is not suitable for using additional drivers.</li> </ol>		

## Mechanical Specification

Unit:mm

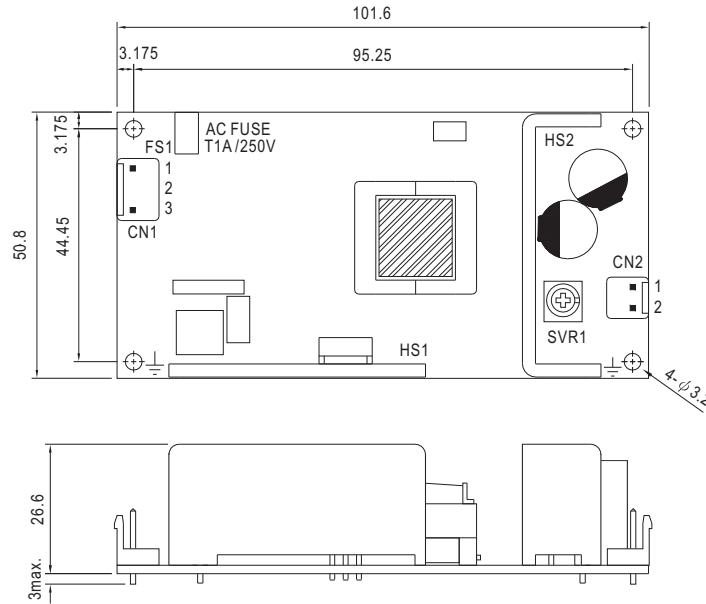

AC Input Connector (CN1) : JST B3P-VH or equivalent

Pin No.	Assignment	Mating Housing	Terminal
1	AC/L	JST VHR or equivalent	JST SVH-21T-P1.1 or equivalent
2	No Pin		
3	AC/N		

DC Output Connector (CN2) : JST B2P-VH or equivalent

Pin No.	Assignment	Mating Housing	Terminal
1	+V	JST VHR or equivalent	JST SVH-21T-P1.1 or equivalent
2	-V		

⚠ HS1,HS2 can not be shorted

⊥ : Grounding required

## Block Diagram

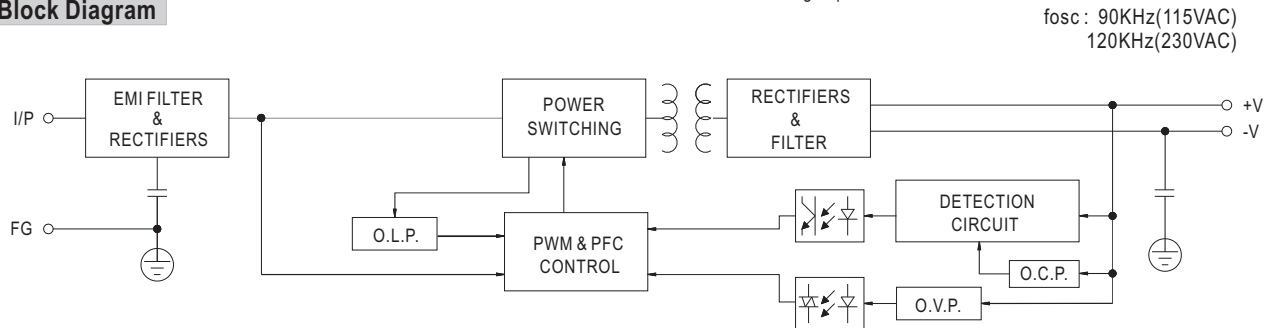

## Derating Curve

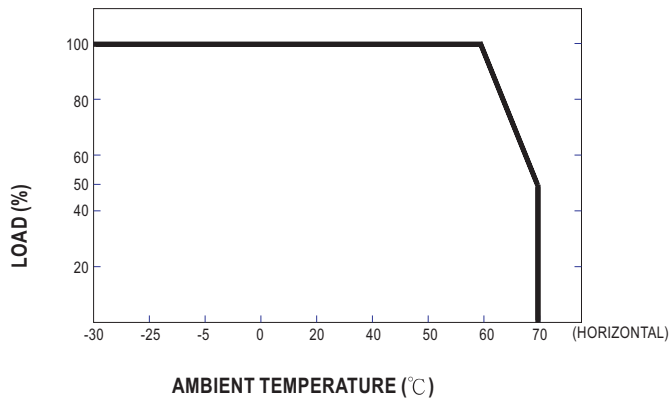

## Static Characteristics

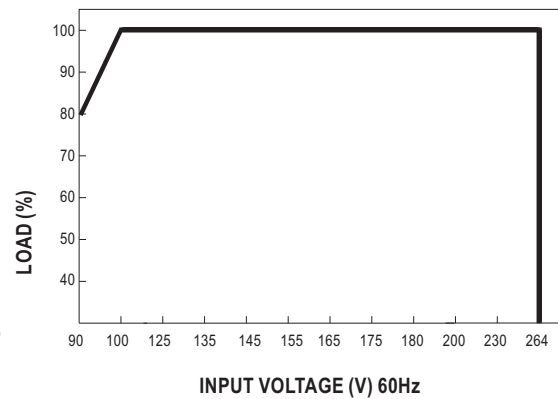

### Power Factor Characteristic

#### Constant Current Mode

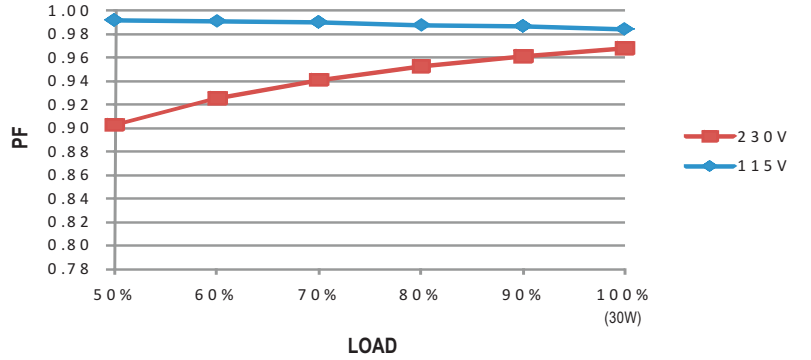

### EFFICIENCY vs LOAD (48V Model)

PLP-30 series possess superior working efficiency that up to 86.5% can be reached in field applications.

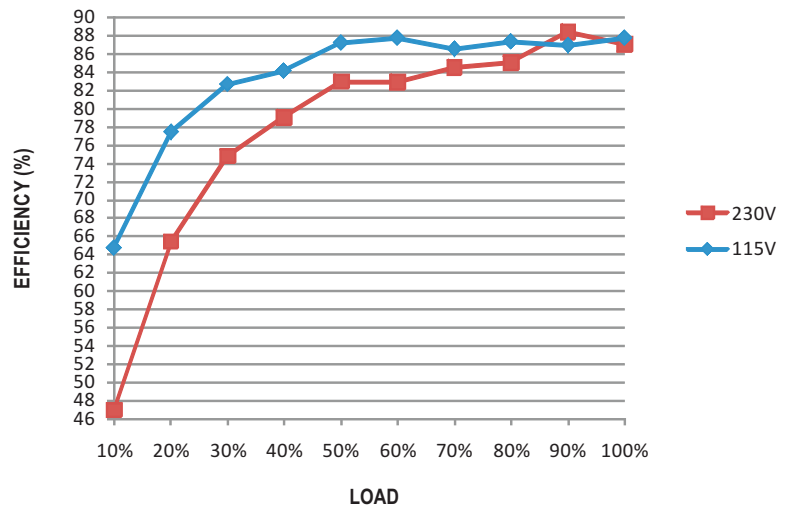

### DRIVING METHODS OF LED MODULE

This LED power supply is suggested to work in constant current mode area (CC) to drive the LEDs.

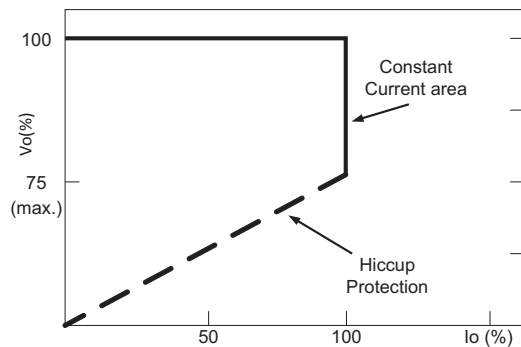

Typical LED power supply I-V curve