

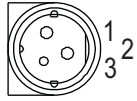

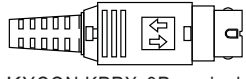







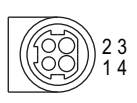
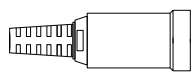

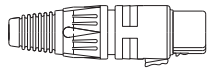

☉ Optional DC plug:

Min. DIN 3 Pin with Lock (male)	Type No.	Pin Assignment	
		PIN No.	Output
   <p>KYCON KPPX-3P equivalent</p>	R6B	1	+Vo
		2	-Vo
		3	+Vo
Min. DIN 4 Pin with Lock (female)	Type No.	Pin Assignment	
   <p>KYCON KPJX-CM-4S equivalent</p>	R7BF	1	+Vo
		2	-Vo
		3	-Vo
		4	+Vo
DIN 5 Pin (male)	Type No.	Pin Assignment	
  	R1B	1	-Vo
		2	-Vo
		3	+Vo
		4	-Vo
		5	+Vo
NEUTRIK XLR NC4FX equivalent	Type No.	Pin Assignment	
  	MIC4	1	+Vo
		2	+Vo
		3	-Vo
		4	-Vo
MOLEX 39-01-2060 (4.2mm) equivalent	Type No.	Pin Assignment	
   <p>FG not connected to output connector</p>	C6P	1	+Vo
		2	+Vo
		3	+Vo
		4	-Vo
		5	-Vo
		6	-Vo
AMP 1-480702-0 (6.35mm) equivalent	Type No.	Pin Assignment	
   <p>FG not connected to output connector</p>	C4P	1	+Vo
		2	+Vo
		3	-Vo
		4	-Vo

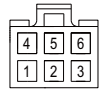
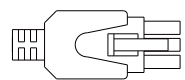
Stripped and tinned leads	Type No.	Pin Assignment	
		PIN No.	Output
 <p>Length of Land L1 by request (MW's standard length, L: <u>25</u> mm, L1: <u>5</u> mm)</p>	by customer	1	+Vo
		2	-Vo

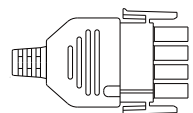
■ **Installation Manual**

Please refer to : <http://www.meanwell.com/manual.html>