

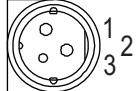

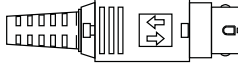







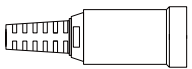

© Optional DC plug:

| Min. DIN 3 Pin with Lock (male) | Type No. | Pin Assignment | |
|---|----------|----------------|--------|
| | | PIN No. | Output |
|    <p>KYCON KPPX-3P equivalent</p> | R6B | 1 | +Vo |
| | | 2 | -Vo |
| | | 3 | +Vo |
| Min. DIN 4 Pin with Lock (female) | Type No. | Pin Assignment | |
|    <p>KYCON KPJX-CM-4S equivalent</p> | R7BF | 1 | +Vo |
| | | 2 | -Vo |
| | | 3 | -Vo |
| | | 4 | +Vo |
| DIN 5 Pin (male) | Type No. | Pin Assignment | |
|    | R1B | 1 | -Vo |
| | | 2 | -Vo |
| | | 3 | +Vo |
| | | 4 | -Vo |
| | | 5 | +Vo |
| NEUTRIK XLR NC4FX equivalent | Type No. | Pin Assignment | |
|    | MIC4 | 1 | +Vo |
| | | 2 | +Vo |
| | | 3 | -Vo |
| | | 4 | -Vo |
| MOLEX 39-01-2060 (4.2mm) equivalent | Type No. | Pin Assignment | |
|    <p>FG not connected to output connector</p> | C6P | 1 | +Vo |
| | | 2 | +Vo |
| | | 3 | +Vo |
| | | 4 | -Vo |
| | | 5 | -Vo |
| | | 6 | -Vo |
| AMP 1-480702-0 (6.35mm) equivalent | Type No. | Pin Assignment | |
|    <p>FG not connected to output connector</p> | C4P | 1 | +Vo |
| | | 2 | +Vo |
| | | 3 | -Vo |
| | | 4 | -Vo |

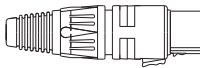
| Stripped and tinned leads | Type No. | Pin Assignment | |
|--|-------------|----------------|--------|
| | | PIN No. | Output |
|  <p>Length of Land L1 by request (MW's standard length, L: <u>25</u> mm, L1: <u>5</u> mm)</p> | by customer | 1 | +Vo |
| | | 2 | -Vo |

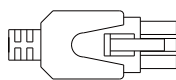
Installation Manual

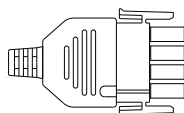
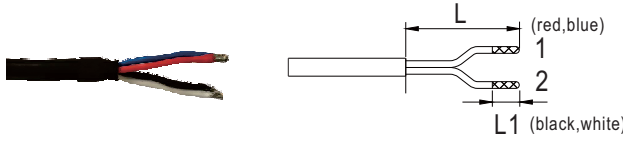
Please refer to : <http://www.meanwell.com/manual.html>